

ANTA
BATTENTE / PIEGHEVOLE

ALFA

HINGED / FOLDING DOOR

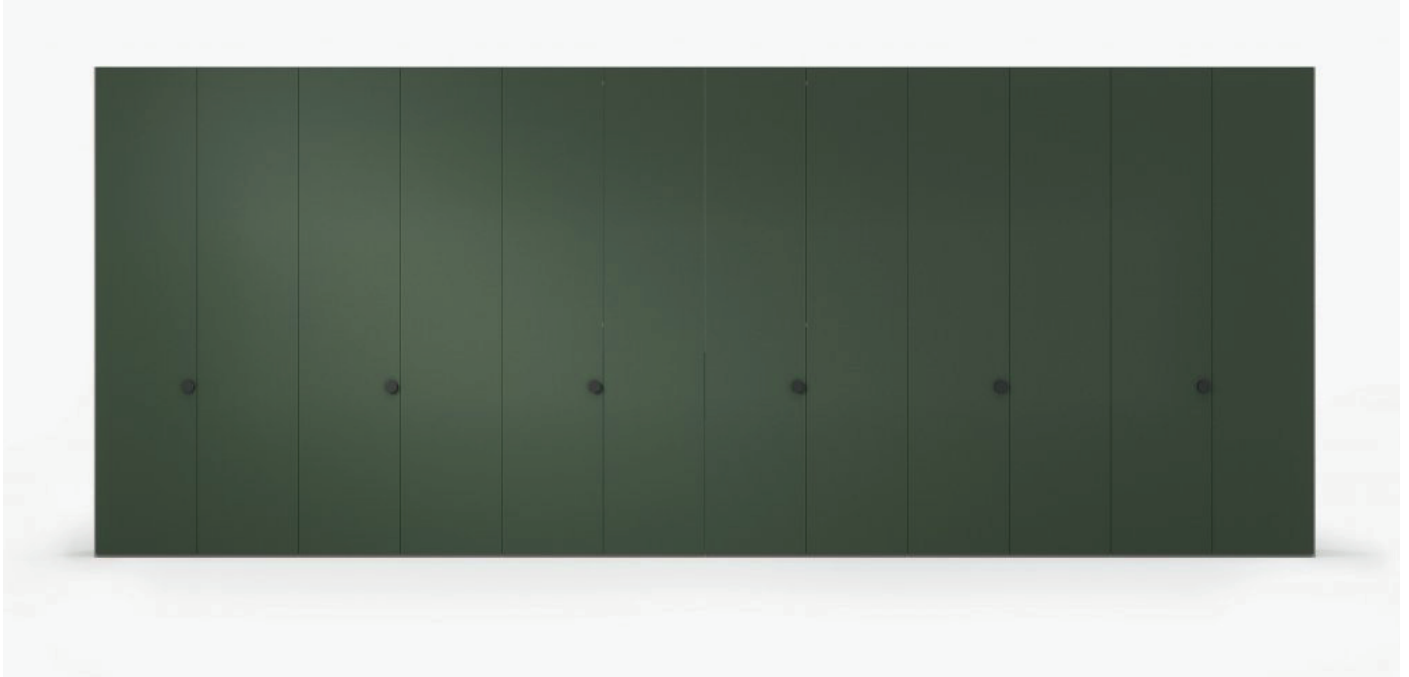

L'armadio anta battente Alfa consente di sviluppare soluzioni personalizzate capaci di risolvere qualsiasi esigenza individuale e di spazio. L'armadio Alfa può essere a incasso, a muro o angolare. Come in tutti gli armadi battenti è possibile prevedere il fianco finale in vetro e attrezzare l'interno con il divisorio telaio e illuminazione LED.

The Alfa hinged door wardrobe allows you to tailor solutions to suit any space requirements and individual needs. The Alfa wardrobe can be recessed, set against a wall or fitted in a corner arrangement. Like all the hinged door wardrobes, it can be designed with a glass end side panel and the interior fitted with the metal frame partition, which also has a LED lighting option.

Anta ALFA dimensioni e modularità / ALFA door: dimensions and module size	p. 03
Caratteristiche tecniche armadi / Wardrobes technical features	p. 04
Modularità armadi / Wardrobes module size	p. 05
Esempi modularità armadi / Module size example	p. 06
Soluzioni progettuali / Design solutions	p. 07
Accessori interni / Internal accessories	p. 14
Illuminazione / Lighting	p. 15

ANTA ALFA / ALFA DOOR



DIMENSIONI / DIMENSIONS

Altezze / Heights

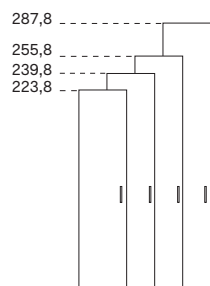

Larghezze / Widths

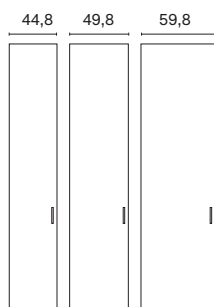

Sezione / Section



Profondità armadio / Wardrobe depth

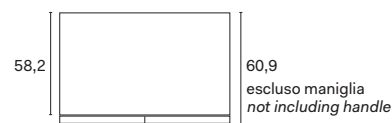

MODULI / MODULES

moduli lineari / straight modules

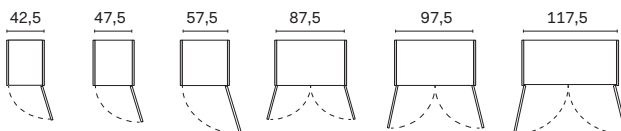

moduli pieghevoli / folding door modules

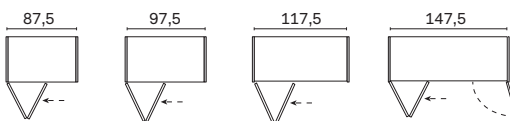

moduli angolo e terminali / corner modules and end units



MANIGLIE / HANDLES

Sono disponibili tutte le maniglie, anche PUSH-PULL.

Can be used with any of the handle options, including PUSH-TO-OPEN system.

RIDUZIONI A MISURA / CUTTING TO SIZE

L'anta ALFA può essere ridotta in larghezza ed altezza.

ALFA doors can be reduced in width and height.

ARMADIO BATTENTE / PIEGHEVOLE HINGED / FOLDING WARDROBE

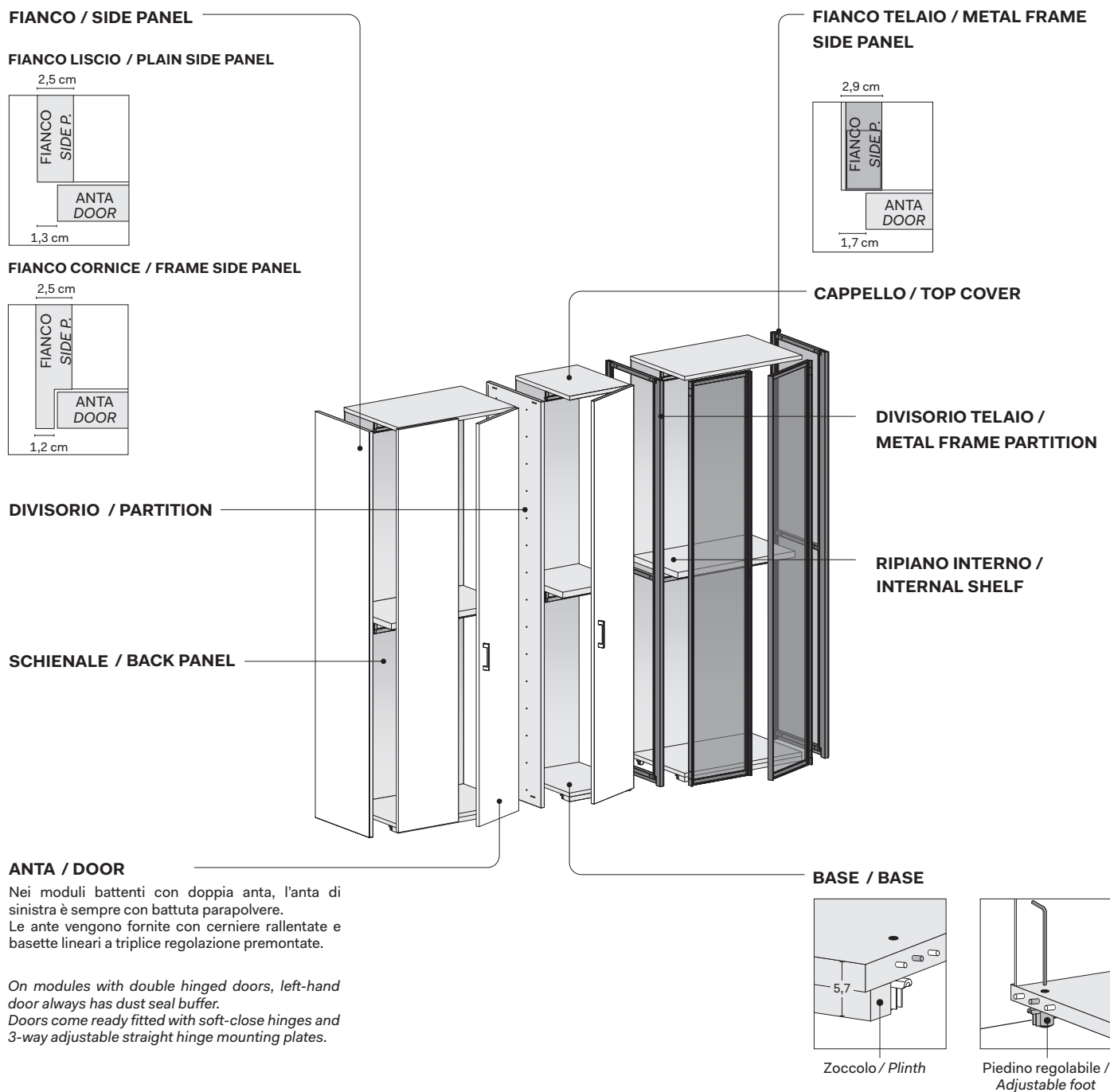

Nei moduli battenti con doppia anta, l'anta di sinistra è sempre con battuta parapolvere. Le ante vengono fornite con cerniere rallentate e basette lineari a triplice regolazione premontate.

On modules with double hinged doors, left-hand door always has dust seal buffer. Doors come ready fitted with soft-close hinges and 3-way adjustable straight hinge mounting plates.

Note per la sicurezza / Notes on safety

L'apertura contemporanea di tutte le ante (per armadio battente o pieghevole) ad armadio completamente vuoto può causarne il ribaltamento, quindi va previsto tassativamente il fissaggio a muro.

Opening all doors (on wardrobes with hinged or folding doors) at the same time with the wardrobe completely empty may cause it to tip over, hence it must be fastened to the wall without exception.

MODULARITA' / MODULE SIZE

MODULI LINEARI / STRAIGHT MODULES

ALTEZZA / HEIGHT

Altezza comprensiva di piedino regolabile.

Height includes adjustable foot.

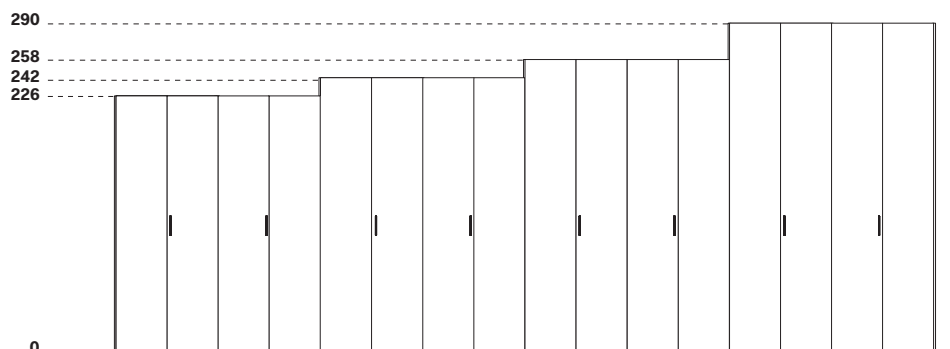

PROFONDITÀ SCOCCA / CARCASS DEPTH

La profondità totale varia in funzione del tipo di anta utilizzata.

Total depth varies depending on the type of door used.

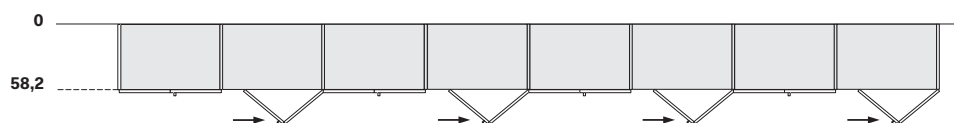

MODULI ANGOLO E TERMINALI TRAPEZIO / CORNER MODULES AND TRAPEZIUM END UNITS

ALTEZZA / HEIGHT

Altezza comprensiva di piedino regolabile.

Height includes adjustable foot.

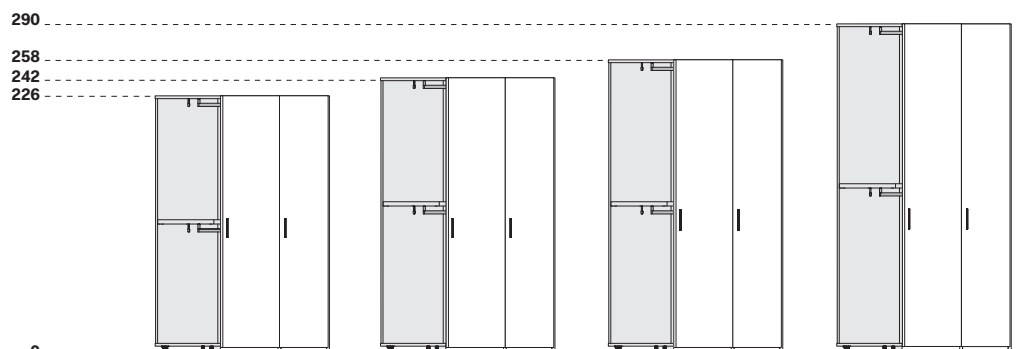

PROFONDITÀ SCOCCA / CARCASS DEPTH

La profondità totale varia in funzione del tipo di anta utilizzata.

Total depth varies depending on the type of door used.

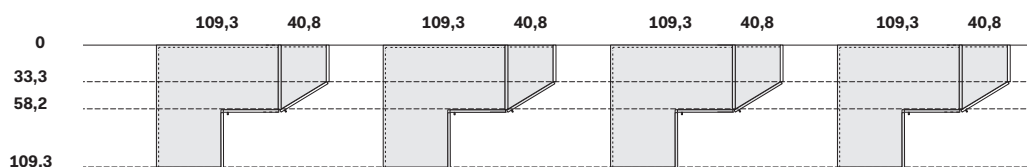

MODULI CURVI / CURVED MODULES

ALTEZZA / HEIGHT

Altezza comprensiva di piedino regolabile.

Height includes adjustable foot.

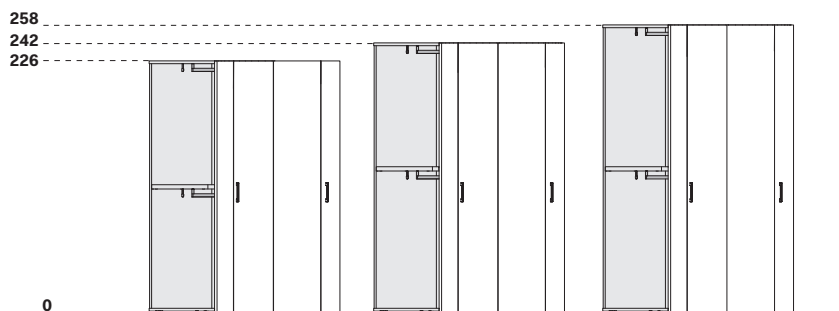

PROFONDITÀ SCOCCA / CARCASS DEPTH

La profondità totale varia in funzione del tipo di anta utilizzata.

Total depth varies depending on the type of door used.

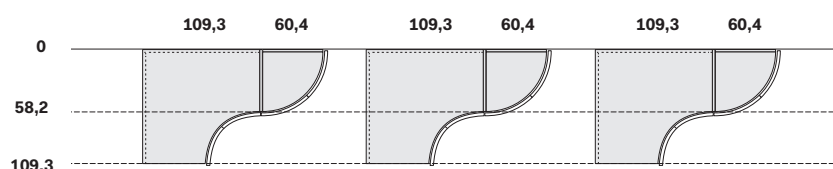

ESEMPI MODULARITA' ARMADI / MODULE SIZE WARDROBES EXAMPLES

Larghezze totali comprensive di fianchi e divisori. Per fianchi TELAIO aggiungere 0,4 cm per fianco.

Total widths including side panels and partitions. For METAL FRAME side panels, add 0,4 cm per side panel.

47,5	42,5	217,5	42,5	47,5	117,5	332,5	87,5	87,5	87,5	57,5
52,5	47,5	222,5	97,5	117,5			87,5	117,5	117,5	
62,5	57,5	227,5	42,5	57,5	117,5	337,5	47,5	117,5	117,5	42,5
92,5	87,5		42,5	87,5	87,5	342,5	97,5	117,5	117,5	
97,5	42,5	47,5	232,5	47,5	57,5	117,5	347,5	42,5	97,5	97,5
102,5	97,5		47,5	87,5	87,5		57,5	117,5	117,5	42,5
107,5	42,5	57,5	237,5	42,5	87,5	97,5	97,5	97,5	97,5	42,5
112,5	47,5	57,5	242,5	57,5	87,5	87,5	352,5	57,5	117,5	117,5
122,5	117,5			117,5	117,5		97,5	97,5	97,5	47,5
137,5	42,5	87,5	247,5	97,5	42,5	97,5	357,5	87,5	97,5	117,5
142,5	47,5	87,5	252,5	97,5	47,5	97,5	362,5	87,5	87,5	87,5
147,5	42,5	97,5	262,5	97,5	57,5	97,5		117,5	117,5	117,5
152,5	47,5	97,5	267,5	42,5	97,5	117,5		97,5	97,5	97,5
	57,5	87,5	272,5	87,5	87,5	87,5	367,5	42,5	97,5	117,5
157,5	42,5	47,5	282,5	87,5	87,5	97,5	372,5	87,5	87,5	87,5
162,5	57,5	97,5	287,5	42,5	117,5	117,5	377,5	87,5	117,5	117,5
167,5	42,5	117,5	292,5	87,5	97,5	97,5	382,5	87,5	97,5	97,5
172,5	47,5	117,5	302,5	57,5	117,5	117,5	387,5	42,5	117,5	117,5
182,5	87,5	87,5		97,5	97,5	97,5	392,5	87,5	87,5	87,5
	57,5	117,5	307,5	42,5	57,5	97,5	97,5	97,5	97,5	87,5
187,5	42,5	47,5	312,5	87,5	97,5	117,5		57,5	117,5	117,5
192,5	87,5	97,5		47,5	97,5	97,5	57,5	117,5	117,5	47,5
197,5	42,5	47,5	317,5	42,5	87,5	87,5	402,5	97,5	97,5	97,5
202,5	97,5	97,5		42,5	47,5	97,5	57,5	117,5	117,5	97,5
207,5	42,5	57,5	322,5	97,5	97,5	117,5	87,5	87,5	97,5	117,5
212,5	87,5	117,5	327,5	87,5	87,5	97,5	87,5	87,5	97,5	42,5

MODULI SOVRAPPONIBILI / STACKABLE MODULES

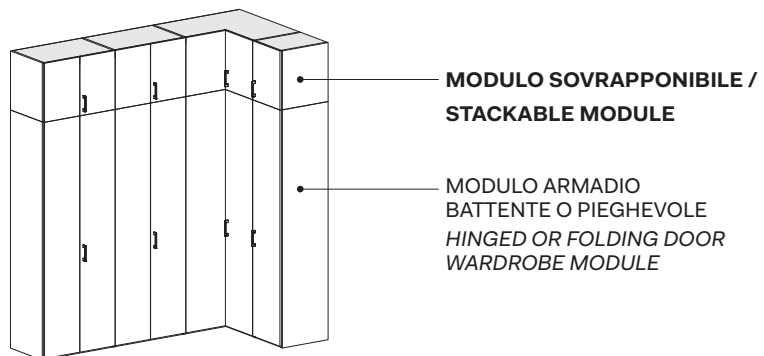

ALTEZZA MODULI / MODULES HEIGHT

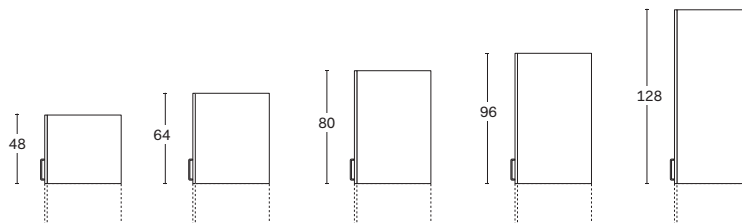

ALTEZZE TOTALI / TOTAL HEIGHTS

Altezza comprensiva di piedino regolabile. / Height includes adjustable foot.

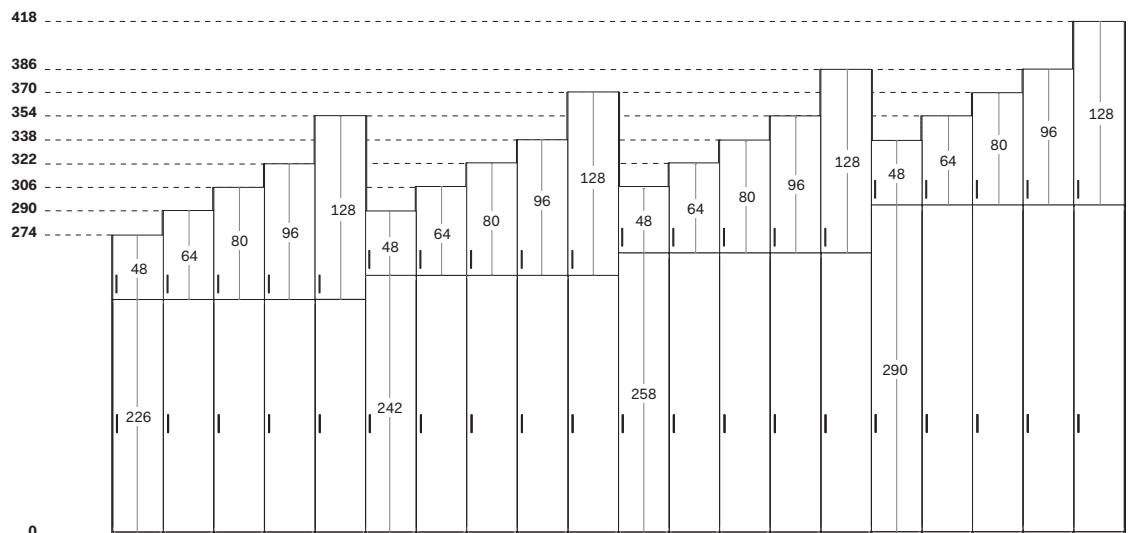

LARGHEZZE E PROFONDITÀ / WIDTHS AND DEPTHS

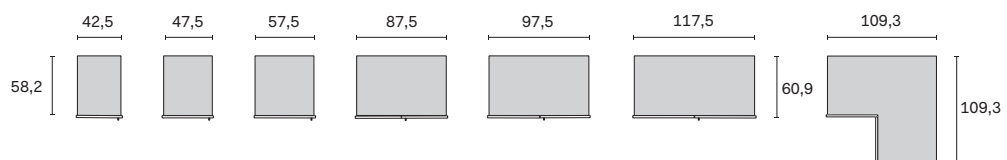

PONTI / BRIDGING UNITS

MODULO PONTE / OVERHEAD STORAGE FOR BRIDGING UNIT

L'apertura delle ante ALFA è possibile anche senza maniglia.
ALFA doors can be opened even without handles.

SCHIENA SOTTOPONTE / BACK PANEL UNDER BRIDGING UNIT

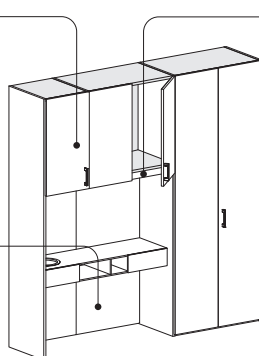

TELAIO SOTTOPONTE / UNDER-BRIDGE FRAME

TELAIO CON SCHIENA SOTTOPONTE / FRAME WITH UNDER-BRIDGE BACK PANELS

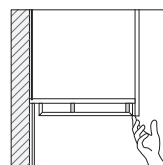

TELAIO SENZA SCHIENA SOTTOPONTE / FRAME WITH NO UNDER-BRIDGE BACK PANELS

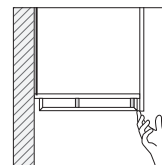

Nello spazio retro al telaio di 2 cm è possibile applicare una luce LED.
A LED light can be installed in the 2cm gap behind the frame.

ALTEZZE MODULI PONTE / BRIDGING UNIT OVERHEAD STORAGE HEIGHTS

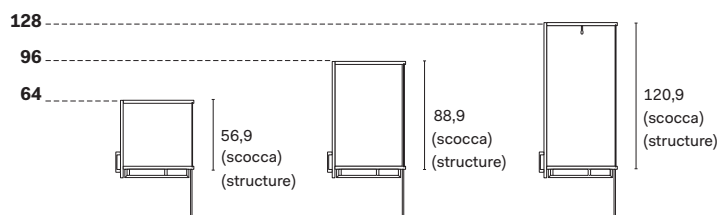

ALTEZZE / HEIGHTS

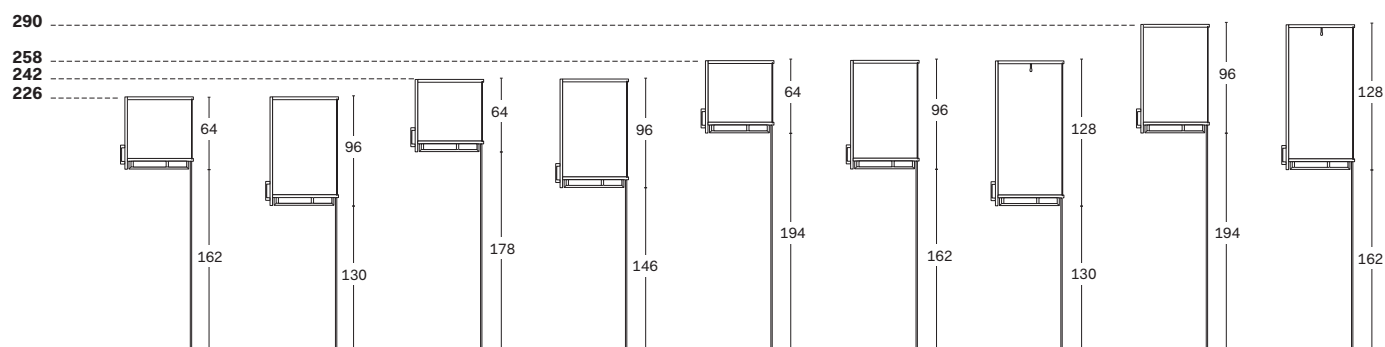

LARGHEZZE E PROFONDITÀ / WIDTHS AND DEPTHS

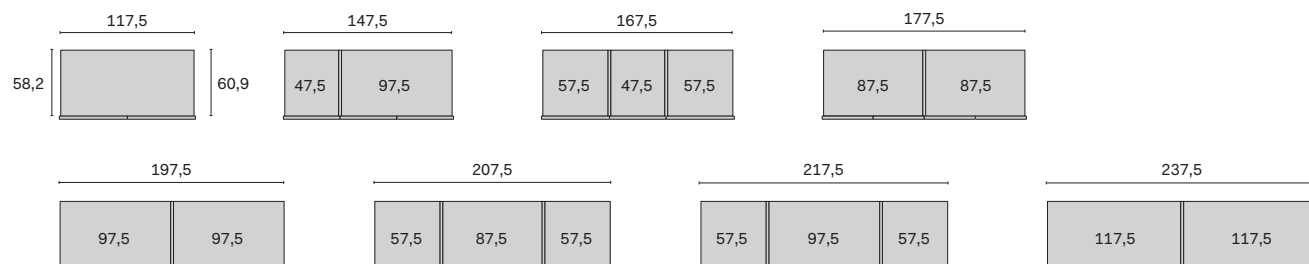

MODULI CON TETRIS / MODULES WITH TETRIS UNIT

FIANCO CORNICE PER TETRIS /
FRAME SIDE PANEL FOR TETRIS

ANTA / DOOR

CONTENITORE TETRIS / TETRIS UNIT

CASSETTONE / OVERSIZED DRAWER

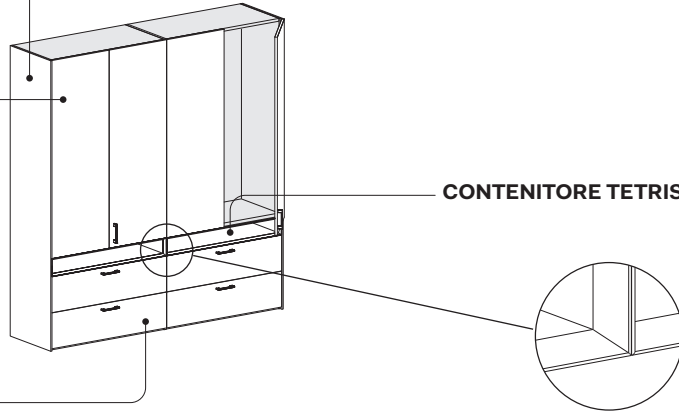

ALTEZZA / HEIGHT

Altezza comprensiva di piedino regolabile. / Height includes adjustable foot.

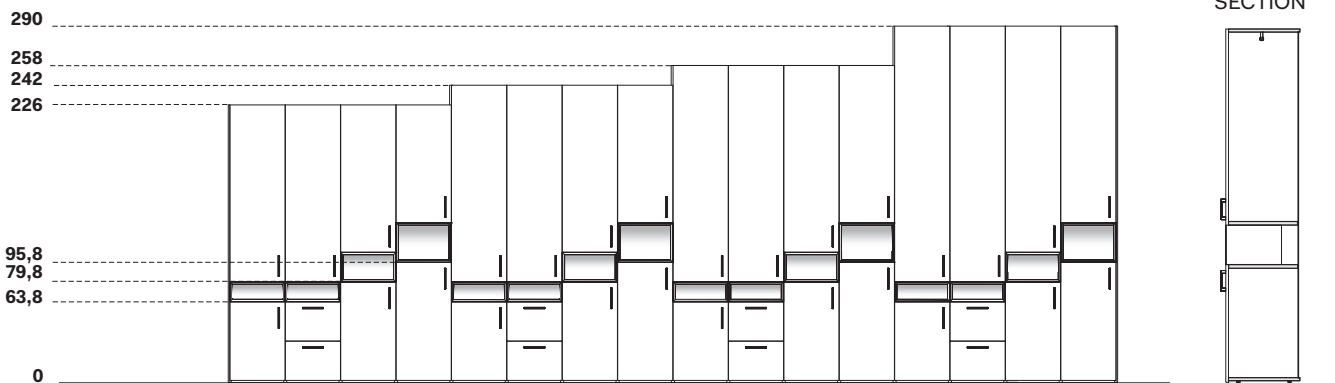

PROFONDITÀ / DEPTH

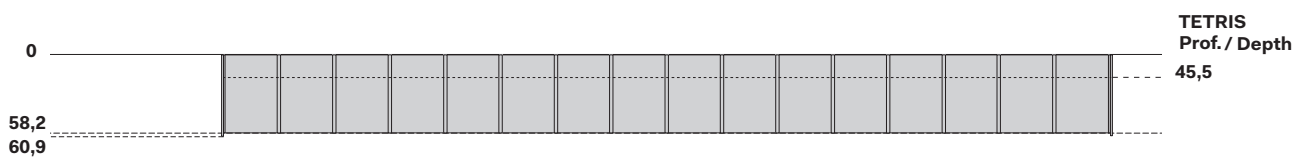

LARGHEZZA / WIDTH

Moduli battenti / Hinged-door modules

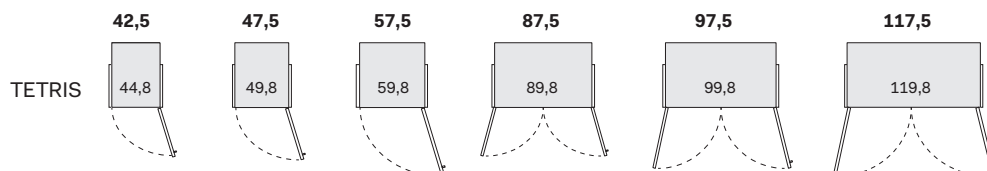

NICCHE / RECESSED

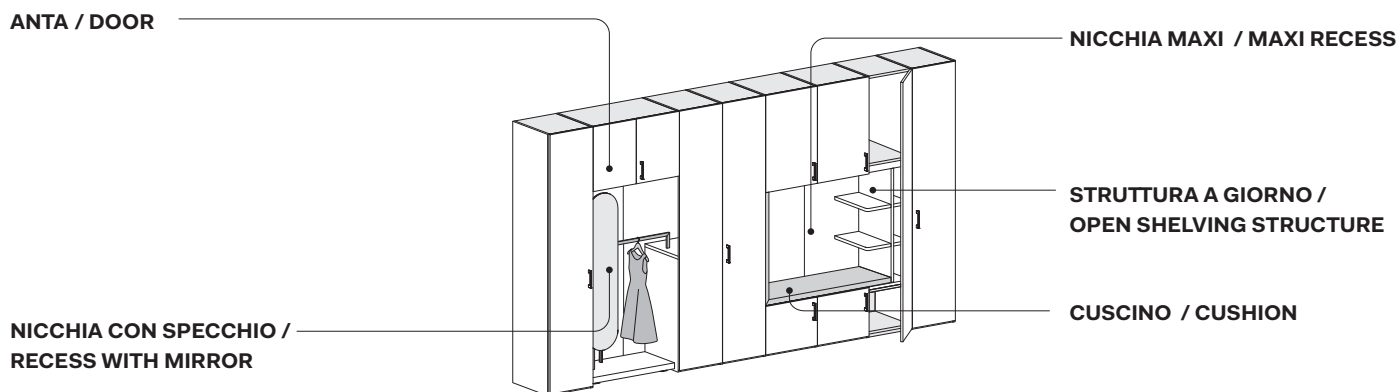

NICCHIA H. 32 / RECESS H 32 cm

ALTEZZA / HEIGHT Altezza comprensiva di piedino regolabile. / Height includes adjustable foot.

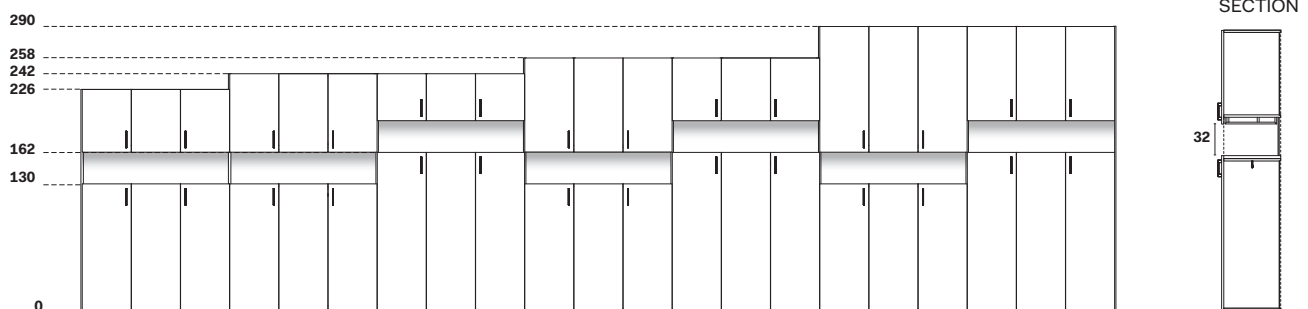

LARGHEZZA / WIDTH

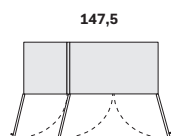

NICCHIA CON SPECCHIO / RECESS WITH MIRROR

ALTEZZA / HEIGHT Altezza comprensiva di piedino regolabile. / Height includes adjustable foot.

SEZIONE / SECTION

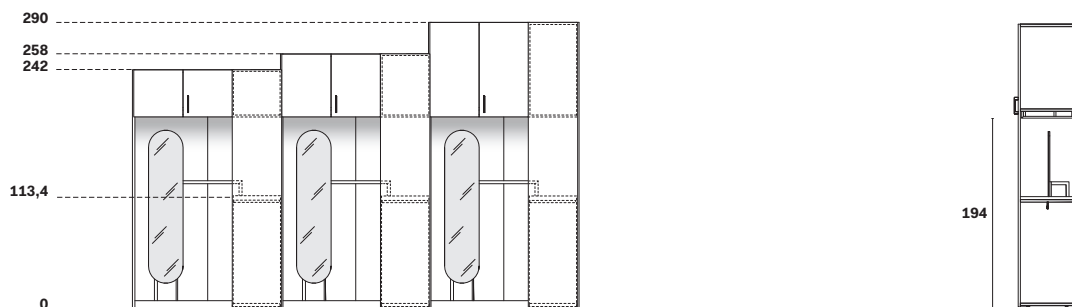

LARGHEZZA / WIDTH

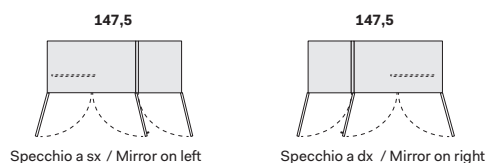

NICCHIA MAXI / MAXI RECESS

ALTEZZA / HEIGHT

Altezza comprensiva di piedino regolabile. / Height includes adjustable foot.

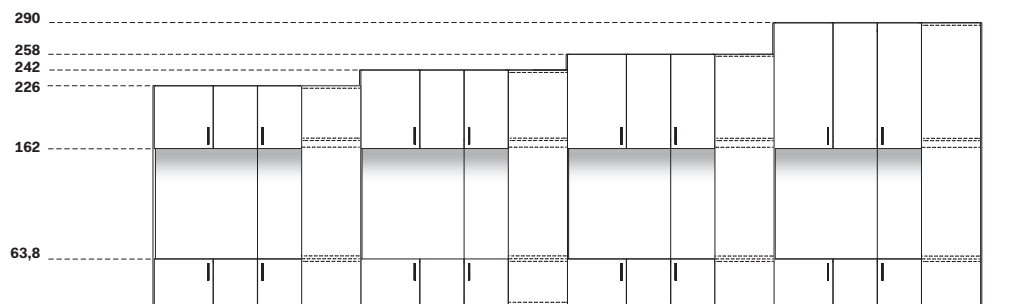

SEZIONE / SECTION

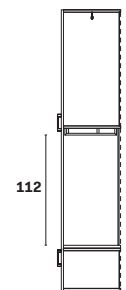

LARGHEZZA / WIDTH

LATO APERTO A SX

* Anta intera a dx, senza maniglia.

OPEN SIDE ON LEFT

* One-piece door on right, no handle.

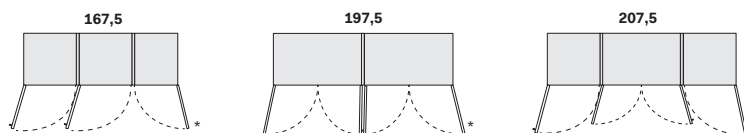

LATO APERTO A DX

* Anta intera a Sx, senza maniglia.

OPEN SIDE ON RIGHT

* One-piece door on left, no handle.

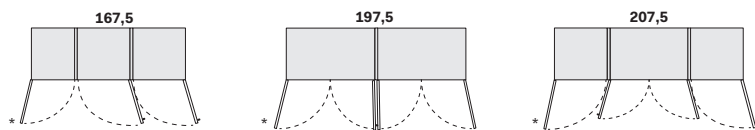

ACCESSORI / EQUIPMENT

Ripiani / Shelves

Sp. 3,8 cm / 3,8 cm thick
Prof. 49 cm / Depth 49 cm



Larghezza / Width
42,5-47,5-57,5-72,5-87,5-
97,5-117,5-132,5-147,5

Con portagruccia /
With coat hanger peg

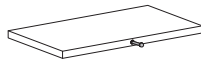

Larghezza / Width
42,5-47,5-57,5-72,5-87,5-
97,5-117,5-132,5-147,5

Ripiani in vetro luminosi / Lit glass shelves

Sp. 3,5 cm / 3,5 cm thick
Prof. 48,7 cm / Depth 48,7 cm

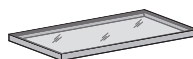

Larghezza / Width
57,5-72,5-87,5-97,5-117,5

Con tubo appendiabito /
With hanger rail

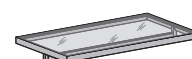

Larghezza / Width
57,5-72,5-87,5-97,5-117,5

Ripiani portascarpe / Shoe rack shelves

Sp. 1,2 cm in folding / Mitre-folded 1,2 cm thick
Prof. 48,7 cm / Depth 48,7 cm

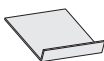

Larghezza / Width
42,5-47,5-57,5-72,5

Crociera interna / Pigeon hole

Sp. 1,2 cm / 1,2 cm thick
Prof. 48,6 cm / Depth 48,6 cm

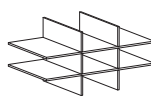

Larghezza / Width
97,5 - 117,5

Appendiabiti / Hangers

STANDARD

Finitura brunito / Bronze finish

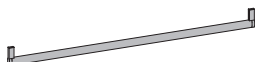

Tutte le larghezze / All widths

PLUS

Finitura brunito / Bronze finish

Guarnizione in gomma / Rubber trim



Tutte le larghezze / All widths

Servetto appendiabiti / Clothes lift

Manuale / Manual

Finitura brunito / Bronze finish

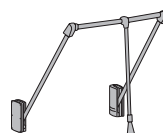

Larghezza / Width
87,5-97,5-117,5

Motorizzato / Motorized

Finitura brunito / Bronze finish

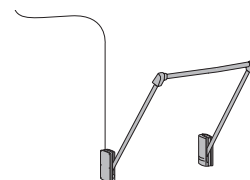

Larghezza / Width
87,5-97,5-117,5

Porta cravatte estraibile / Pull-out tie organizer

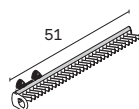

Appendiabiti estraibile P. 36 cm / Pull-out hanging rail D 36 cm

Finitura alluminio satinato / Satin aluminium finish



Specchiera interno anta / Inside door mirror

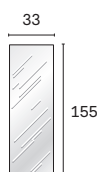

Specchiera orientabile / Revolving mirror

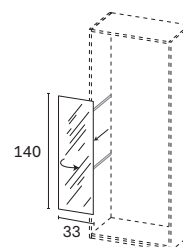
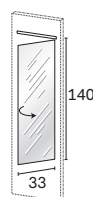

Attrezzatura estraibile / Pull-out fittings

Vassoio estraibile / Pull-out tray

Finitura brunito / Bronze finish

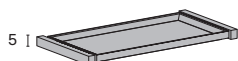

Larghezza / Width
72,5-87,5-97,5-117,5

Porta pantaloni estraibile / Pull-out trouser rack

Finitura brunito / Bronze finish

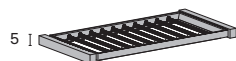

Larghezza / Width
72,5-87,5-97,5-117,5

Porta sacche estraibile / Pull-out garment box

Finitura brunito / Bronze finish



Larghezza / Width
87,5-97,5

Scarpiera estraibile / Pull-out shoe rack

Finitura brunito / Bronze finish

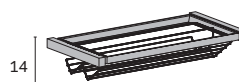

Larghezza / Width
87,5-97,5-117,5

Cestello estraibile / Pull-out basket

Finitura brunito / Bronze finish



Larghezza / Width
87,5-97,5

Attrezzatura estraibile con frontale / Pull-out fittings with front

Vassoio estraibile / Pull-out tray

Finitura brunito / Bronze finish

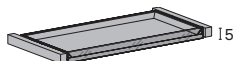

Larghezza / Width
72,5-87,5-97,5-117,5

Porta pantaloni estraibile / Pull-out trouser rack

Finitura brunito / Bronze finish



Larghezza / Width
72,5-87,5-97,5-117,5

Vassoio estraibile / Pull-out tray

Finitura brunito / Bronze finish

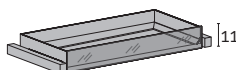

Larghezza / Width
72,5-87,5-97,5-117,5

Vassoio estraibile / Pull-out tray

Finitura brunito / Bronze finish

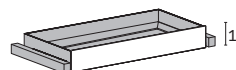

Larghezza / Width
72,5-87,5-97,5-117,5

Vassoi in folding / Mitre-folded trays

In folding sp. 0,8 cm / Mitre-folded 0,8 cm thick

Altezza 5 cm / Height 5 cm

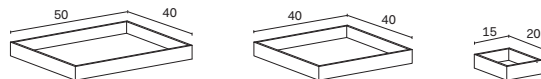

Combinazioni possibili / Possible combinations

Per VASSOIO L. 72,5 cm
/ For TRAY W 72,5 cm



Per VASSOIO L. 87,5 cm
/ For TRAY W 87,5 cm



Per VASSOIO L. 97,5 cm
/ For TRAY W 97,5 cm



Per VASSOIO L. 117,5 cm
/ For TRAY W 117,5 cm



Vaschette interne / Tray inserts

In 03Z Similpelle / In 03Z Leatherette

Altezza 5 cm / Height 5 cm

porta oggetti /
tidy tray

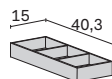

porta cravatte /
tie organizer

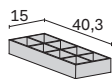

porta anelli /
ring organizer

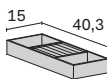

porta orologi /
watch organizer

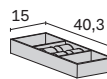

CASSETTIERE INTERNE / INTERNAL DRAWER UNITS

Tutte le cassettiere sono da completare con il top. / All drawer units need to be finished off with a top.

Con maniglia standard / With standard handle

Prof. 48,7 cm / Depth 48,7 cm

Altezza / Height

33,8

Anche in prof. 33,7 cm /
Also depth 33,7 cm



Larghezza / Width

42,5-47,5-57,5-72,5-87,5-
97,5-117,5

Altezza / Height

33,8

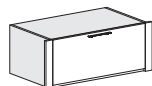

Larghezza / Width

87,5-97,5

Altezza / Height

49,7



Larghezza / Width

42,5-47,5-57,5-72,5-87,5-
97,5-117,5

Altezza / Height

65,5



Larghezza / Width

42,5-47,5-57,5-72,5-87,5-
97,5-117,5

Altezza / Height

81,5

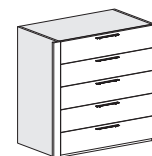

Larghezza / Width

42,5-47,5-57,5-72,5-87,5-
97,5-117,5

Con maniglia PLUS / With PLUS handle

Prof. 48,7 cm / Depth 48,7 cm

Altezza / Height

33,8

Anche in prof. 33,7 cm /
Also depth 33,7 cm

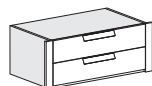

Larghezza / Width

42,5-47,5-57,5-72,5-87,5-
97,5-117,5

Altezza / Height

33,8

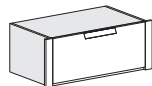

Larghezza / Width

87,5-97,5

Altezza / Height

49,7

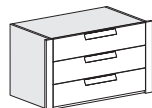

Larghezza / Width

42,5-47,5-57,5-72,5-87,5-
97,5-117,5

Altezza / Height

65,5

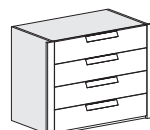

Larghezza / Width

42,5-47,5-57,5-72,5-87,5-
97,5-117,5

Altezza / Height

81,5

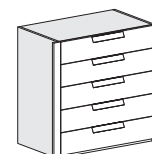

Larghezza / Width

42,5-47,5-57,5-72,5-87,5-
97,5-117,5

Con maniglia GOLA / With GOLA profile

per fianco e divisorio TELAIO / for METAL FRAME side panel and partition

Prof. 51 cm / Depth 51 cm

Altezza / Height

38,5 cm

Da fissare sempre in sospensione sotto un ripiano sp. 3,8 cm /
Always needs to be attached to the underside of a shelf 3,8 cm thick.

Gola in finitura brunita. / Profile in bronze finish.

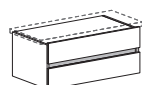

Larghezza / Width
35-40-50-80-90-110

Altezza / Height

59,7 cm

Da fissare sempre in sospensione sotto un ripiano sp. 3,8 cm /
Always needs to be attached to the underside of a shelf 3,8 cm thick.

Gola in finitura brunita. / Profile in bronze finish.

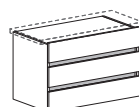

Larghezza / Width
35-40-50-80-90-110

ILLUMINAZIONE / LIGHTING

24V 3000K

Luci LED verticali / Vertical LED lights per fianchi e divisori / for side panels and partitions

Da completare con trasformatore ed eventuali accessori in base al sistema di accensione scelto.

To be finished off with transformer and accessories, if any, based on the ON/OFF control system chosen.

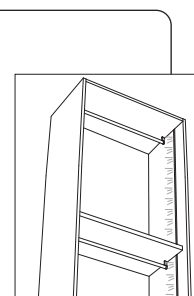

**Profilo LED verticale orientato /
Inward-facing vertical LED strip**

Luci LED orizzontali / Horizontal LED lights per cappelli e ripiani / for top covers and shelves

Da completare con trasformatore ed eventuali accessori in base al sistema di accensione scelto.

To be finished off with transformer and accessories, if any, based on the ON/OFF control system chosen.

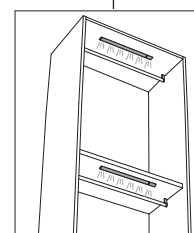

**Luci LED parziali /
Partial LED lights**

Luci LED verticali e orizzontali / Vertical and horizontal LED lights

Da completare con trasformatore ed eventuali accessori in base al sistema di accensione scelto.

To be finished off with transformer and accessories, if any, based on the ON/OFF control system chosen.

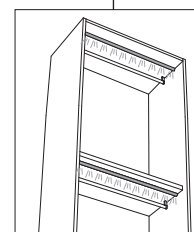
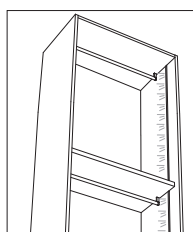

**Luci LED a tutto vano /
Full-width LED lights**

**Profilo LED verticale orientato /
Inward-facing vertical LED strip**