

ANTA
SCORREVOLE
DOVER
SLIDING DOOR



Linee in evidenza per l'armadio con anta scorrevole Dover. Disponibile in tutti i laccati opachi e ossidati, nelle finiture ecolegno e super-matt.

Lines are highlighted on the wardrobe with Dover sliding doors. Available in all matt and oxidized lacquered colours and in the eco-wood and super-matt finishes.

Anta DOVER dimensioni e modularità / DOVER door: dimensions and module size	p. 03
Caratteristiche tecniche armadi / Wardrobes technical features	p. 04
Modularità armadi / Wardrobes module size	p. 05
Esempi modularità armadi / Module size example	p. 06
Accessori interni / Internal accessories	p. 07
Illuminazione / Lighting	p. 10

ANTA DOVER / DOVER DOOR

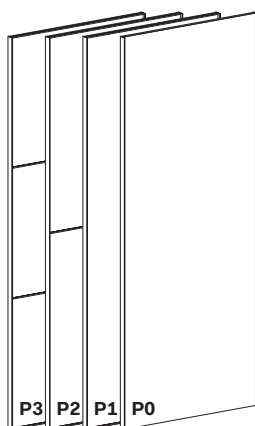

DIMENSIONI / DIMENSIONS

Altezze / Heights

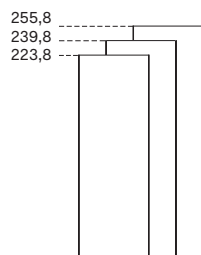

Larghezze / Widths

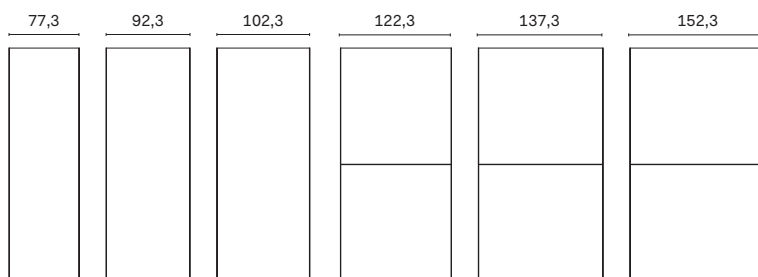

Sezione / Section

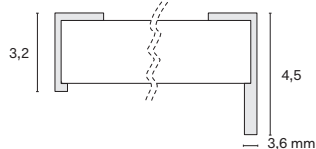

Profondità armadio / Wardrobe depth

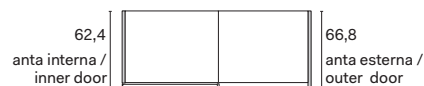

MODULI / MODULES

moduli scorrevoli / sliding door modules

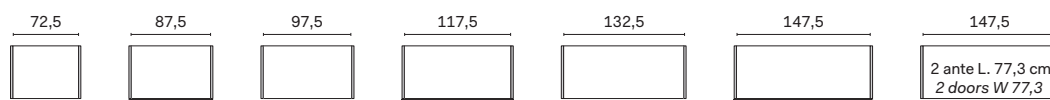

moduli scorrevoli angolo / sliding door corner module

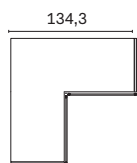

MANIGLIE / HANDLES

Profilo verticale a tutta altezza.
L'anta interna viene fornita con un profilo P. 4,5 cm e un profilo P. 3,2 cm.
L'anta esterna viene fornita con 2 profili P. 4,5 cm.

*Full-height vertical profile.
The inner door comes with a 4,5cm-deep profile and a 3,2cm-deep profile.
The outer door comes with two 4,5cm-deep profiles.*

RIDUZIONI A MISURA / CUTTING TO SIZE

L'anta DOVER può essere ridotta in larghezza e altezza.
DOVER doors can be reduced in width and height.

ARMADIO SCORREVOLE SLIDING WARDROBE

FIANCO / SIDE PANEL

PER ANTA INTERNA / FOR INNER DOOR



PER ANTA ESTERNA / FOR OUTER DOOR

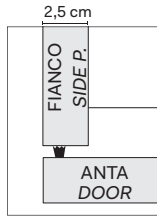

RIPIANO INTERNO / INTERNAL SHELF

SCHIENALE / BACK PANEL

BASE / BASE

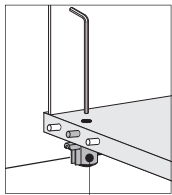

Piedino regolabile /
Adjustable foot

CAPPELLO / TOP COVER

SISTEMA DI SCORRIMENTO / SLIDING SYSTEM

DIVISORIO / PARTITION

ANTA / DOOR

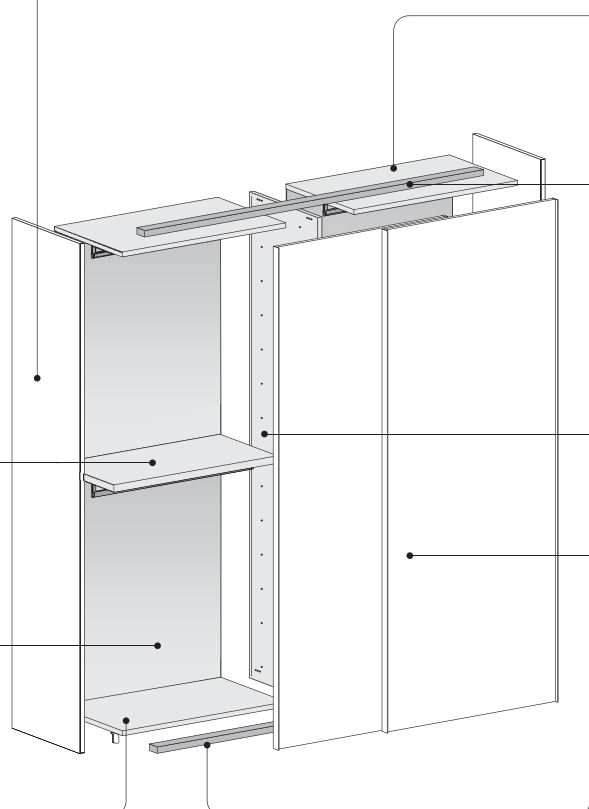

Note per la sicurezza / Notes on safety

È consigliabile posizionare l'armadio lontano da fonti di calore e dalla luce solare diretta.

It is advisable to position the wardrobe away from sources of heat and out of direct sunlight.

MODULI SCORREVOLI / SLIDING MODULES

ALTEZZA / HEIGHT

Altezza comprensiva di piedino regolabile.

Height includes adjustable foot.

Per l'altezza finita dell'armadio, aggiungere 2 cm di ingombro del carrello dell'anta.

To get the finished height of the wardrobe, add 2 cm to allow for the space taken up by the door's runner.

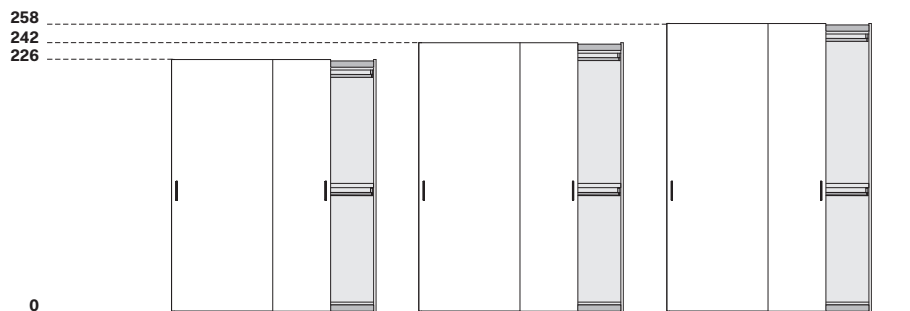

PROFONDITÀ SCOCCA / CARCASS DEPTH

La profondità totale varia in funzione del tipo di anta utilizzata.

Total depth varies depending on the type of door used.



MODULI ANGOLO / CORNER MODULES

ALTEZZA / HEIGHT

Altezza comprensiva di piedino regolabile.

Height includes adjustable foot.

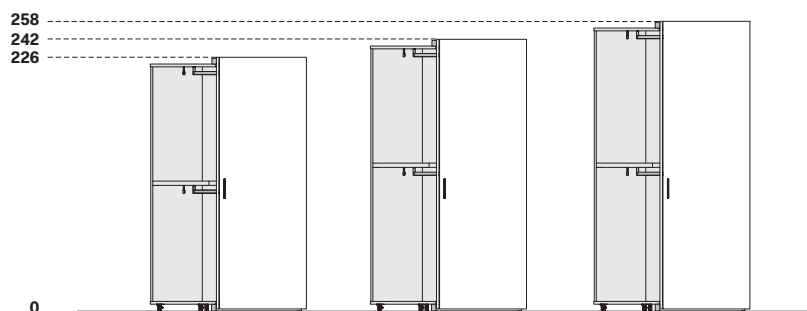

PROFONDITÀ SCOCCA / CARCASS DEPTH

La profondità totale varia in funzione del tipo di anta utilizzata.

Total depth varies depending on the type of door used.

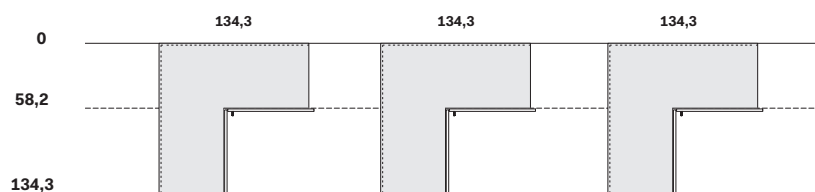

ESEMPI MODULARITÀ ARMADI / MODULE SIZE WARDROBES EXAMPLES

Verificare modularità armadi in base al modello di anta / Check module size wardrobes upon door type

152,5	72,5	72,5
--------------	------	------

167,5	72,5	87,5
--------------	------	------

177,5	72,5	97,5
--------------	------	------

182,5	87,5	87,5
--------------	------	------

202,5	97,5	97,5
--------------	------	------

227,5	72,5	72,5	72,5
--------------	------	------	------

242,5	117,5	117,5
--------------	-------	-------

72,5	87,5	72,5
------	------	------

252,5	72,5	97,5	72,5
--------------	------	------	------

272,5	132,5	132,5
--------------	-------	-------

87,5	87,5	87,5
------	------	------

277,5	72,5	97,5	97,5
--------------	------	------	------

302,5	147,5	147,5
--------------	-------	-------

97,5	97,5	97,5
------	------	------

72,5	147,5	72,5
------	-------	------

72,5	72,5	72,5	72,5
------	------	------	------

327,5	97,5	147,5	72,5
--------------	------	-------	------

352,5	97,5	147,5	97,5
--------------	------	-------	------

97,5	72,5	72,5	97,5
------	------	------	------

362,5	117,5	117,5	117,5
--------------	-------	-------	-------

87,5	87,5	87,5	87,5
------	------	------	------

402,5	97,5	97,5	97,5	97,5
--------------	------	------	------	------

407,5	132,5	132,5	132,5
--------------	-------	-------	-------

452,5	147,5	147,5	147,5
--------------	-------	-------	-------

ACCESSORI / EQUIPMENT

Ripiani / Shelves

Sp. 3,8 cm / 3,8 cm thick
Prof. 49 cm / Depth 49 cm



Larghezza / Width
42,5-47,5-57,5-72,5-87,5-
97,5-117,5-132,5-147,5

Con portagruccia /
With coat hanger peg

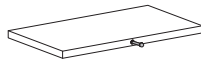

Larghezza / Width
42,5-47,5-57,5-72,5-87,5-
97,5-117,5-132,5-147,5

Ripiani in vetro luminosi / Lit glass shelves

Sp. 3,5 cm / 3,5 cm thick
Prof. 48,7 cm / Depth 48,7 cm

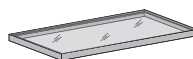

Larghezza / Width
57,5-72,5-87,5-97,5-117,5

Con tubo appendiabito /
With hanger rail

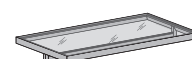

Larghezza / Width
57,5-72,5-87,5-97,5-117,5

Ripiani portascarpe / Shoe rack shelves

Sp. 1,2 cm in folding / Mitre-folded 1,2 cm thick
Prof. 48,7 cm / Depth 48,7 cm

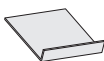

Larghezza / Width
42,5-47,5-57,5-72,5

Crociera interna / Pigeon hole

Sp. 1,2 cm / 1,2 cm thick
Prof. 48,6 cm / Depth 48,6 cm

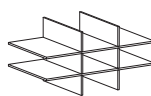

Larghezza / Width
97,5 - 117,5

Appendiabiti / Hangers

STANDARD

Finitura brunito / Bronze finish

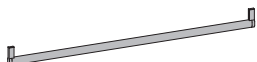

Tutte le larghezze / All widths

PLUS

Finitura brunito / Bronze finish

Guarnizione in gomma / Rubber trim



Tutte le larghezze / All widths

Servetto appendiabiti / Clothes lift

Manuale / Manual

Finitura brunito / Bronze finish

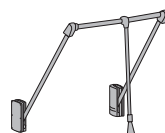

Larghezza / Width
87,5-97,5-117,5

Motorizzato / Motorized

Finitura brunito / Bronze finish

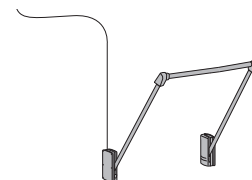

Larghezza / Width
87,5-97,5-117,5

Porta cravatte estraibile / Pull-out tie organizer

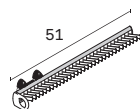

Appendiabiti estraibile P. 36 cm / Pull-out hanging rail D 36 cm

Finitura alluminio satinato / Satin aluminium finish



Specchiera interno anta / Inside door mirror

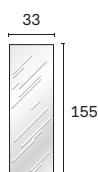

Specchiera orientabile / Revolving mirror

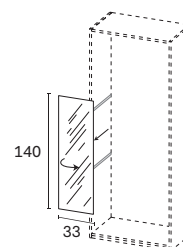
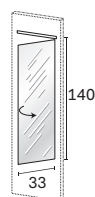

Attrezzatura estraibile / Pull-out fittings

Vassoio estraibile / Pull-out tray

Finitura brunito / Bronze finish

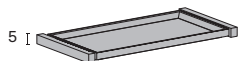

Larghezza / Width
72,5-87,5-97,5-117,5

Porta pantaloni estraibile / Pull-out trouser rack

Finitura brunito / Bronze finish

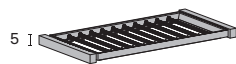

Larghezza / Width
72,5-87,5-97,5-117,5

Porta sacche estraibile / Pull-out garment box

Finitura brunito / Bronze finish



Larghezza / Width
87,5-97,5

Scarpiera estraibile / Pull-out shoe rack

Finitura brunito / Bronze finish

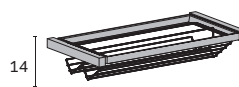

Larghezza / Width
87,5-97,5-117,5

Cestello estraibile / Pull-out basket

Finitura brunito / Bronze finish



Larghezza / Width
87,5-97,5

Attrezzatura estraibile con frontale / Pull-out fittings with front

Vassoio estraibile / Pull-out tray

Finitura brunito / Bronze finish

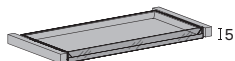

Larghezza / Width
72,5-87,5-97,5-117,5

Porta pantaloni estraibile / Pull-out trouser rack

Finitura brunito / Bronze finish



Larghezza / Width
72,5-87,5-97,5-117,5

Vassoio estraibile / Pull-out tray

Finitura brunito / Bronze finish

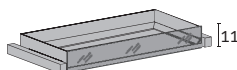

Larghezza / Width
72,5-87,5-97,5-117,5

Vassoio estraibile / Pull-out tray

Finitura brunito / Bronze finish

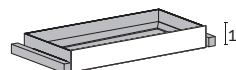

Larghezza / Width
72,5-87,5-97,5-117,5

Vassoi in folding / Mitre-folded trays

In folding sp. 0,8 cm / Mitre-folded 0,8 cm thick

Altezza 5 cm / Height 5 cm

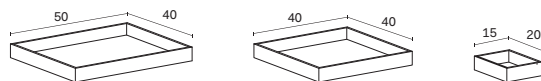

Combinazioni possibili / Possible combinations

Per VASSOIO L. 72,5 cm
/ For TRAY W 72,5 cm



Per VASSOIO L. 87,5 cm
/ For TRAY W 87,5 cm



Per VASSOIO L. 97,5 cm
/ For TRAY W 97,5 cm



Per VASSOIO L. 117,5 cm
/ For TRAY W 117,5 cm



Vaschette interne / Tray inserts

In 03Z Similpelle / In 03Z Leatherette

Altezza 5 cm / Height 5 cm

porta oggetti /
tidy tray

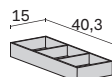

porta cravatte /
tie organizer

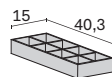

porta anelli /
ring organizer

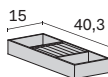

porta orologi /
watch organizer

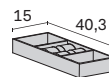

CASSETTIERE INTERNE / INTERNAL DRAWER UNITS

Tutte le cassettiere sono da completare con il top. / All drawer units need to be finished off with a top.

Con maniglia standard / With standard handle

Prof. 48,7 cm / Depth 48,7 cm

Altezza / Height

33,8

Anche in prof. 33,7 cm /
Also depth 33,7 cm



Larghezza / Width

42,5-47,5-57,5-72,5-87,5-
97,5-117,5

Altezza / Height

33,8

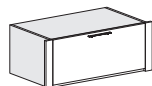

Larghezza / Width

87,5-97,5

Altezza / Height

49,7



Larghezza / Width

42,5-47,5-57,5-72,5-87,5-
97,5-117,5

Altezza / Height

65,5



Larghezza / Width

42,5-47,5-57,5-72,5-87,5-
97,5-117,5

Altezza / Height

81,5



Larghezza / Width

42,5-47,5-57,5-72,5-87,5-
97,5-117,5

Con maniglia PLUS / With PLUS handle

Prof. 48,7 cm / Depth 48,7 cm

Altezza / Height

33,8

Anche in prof. 33,7 cm /
Also depth 33,7 cm

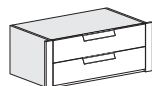

Larghezza / Width

42,5-47,5-57,5-72,5-87,5-
97,5-117,5

Altezza / Height

33,8

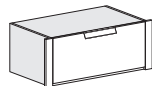

Larghezza / Width

87,5-97,5

Altezza / Height

49,7

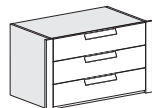

Larghezza / Width

42,5-47,5-57,5-72,5-87,5-
97,5-117,5

Altezza / Height

65,5

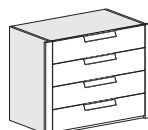

Larghezza / Width

42,5-47,5-57,5-72,5-87,5-
97,5-117,5

Altezza / Height

81,5

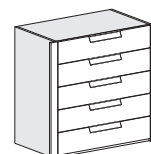

Larghezza / Width

42,5-47,5-57,5-72,5-87,5-
97,5-117,5

Con maniglia GOLA / With GOLA profile

per fianco e divisorio TELAIO / for METAL FRAME side panel and partition

Prof. 51 cm / Depth 51 cm

Altezza / Height

38,5 cm

Da fissare sempre in sospensione sotto un ripiano sp. 3,8 cm /
Always needs to be attached to the underside of a shelf 3,8 cm thick.

Gola in finitura brunita. / Profile in bronze finish.

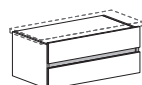

Larghezza / Width
35-40-50-80-90-110

Altezza / Height

59,7 cm

Da fissare sempre in sospensione sotto un ripiano sp. 3,8 cm /
Always needs to be attached to the underside of a shelf 3,8 cm thick.

Gola in finitura brunita. / Profile in bronze finish.

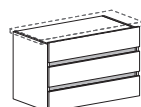

Larghezza / Width
35-40-50-80-90-110

ILLUMINAZIONE / LIGHTING

24V 3000K

Luci LED verticali / Vertical LED lights per fianchi e divisori / for side panels and partitions

Da completare con trasformatore ed eventuali accessori in base al sistema di accensione scelto.

To be finished off with transformer and accessories, if any, based on the ON/OFF control system chosen.

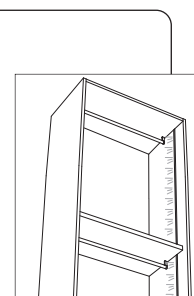

**Profilo LED verticale orientato /
Inward-facing vertical LED strip**

Luci LED orizzontali / Horizontal LED lights per cappelli e ripiani / for top covers and shelves

Da completare con trasformatore ed eventuali accessori in base al sistema di accensione scelto.

To be finished off with transformer and accessories, if any, based on the ON/OFF control system chosen.

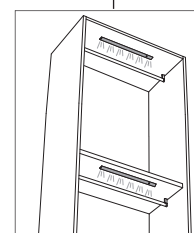

**Luci LED parziali /
Partial LED lights**

Luci LED verticali e orizzontali / Vertical and horizontal LED lights

Da completare con trasformatore ed eventuali accessori in base al sistema di accensione scelto.

To be finished off with transformer and accessories, if any, based on the ON/OFF control system chosen.

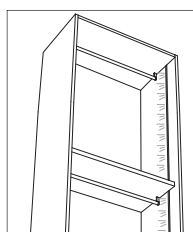

**Profilo LED verticale orientato /
Inward-facing vertical LED strip**

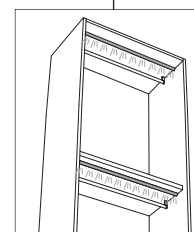

**Luci LED a tutto vano /
Full-width LED lights**