



Il nuovo tassello rotondo in metallo per le mensole Duo, rinnovato nella forma, mantiene allineate le superfici che vengono affiancate.

The new round metal insert for the Duo shelves, with its all-new shape, keeps adjoining surfaces aligned.

NOVAMOBILI

DUO

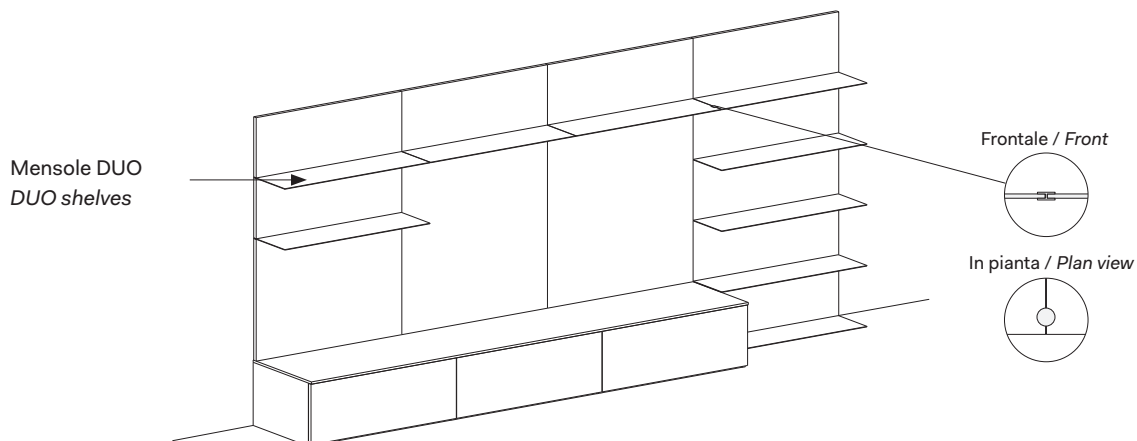

Vista laterale
Lateral view

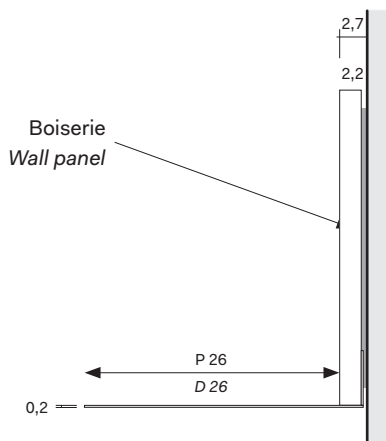

Vanno sempre fissate nella parte inferiore di un pannello boiserie sp. 2,7.
They must always be fastened at the bottom of a 2,7cm-thick wall panel.

MENSOLE DUO PER BOISERIE SP. 2,7 CM DUO SHELVES FOR 2,7 CM-THICK WALL PANNELLING

In metallo
Metal

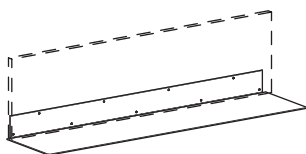

Spessore Thickness	Altezza Height	Larghezza Width	Profondità Depth
<u>0,2 cm</u>	<u>10 cm</u>	<u>89,8 cm</u> <u>119,8 cm</u>	<u>26 cm</u>

Non sono possibili riduzioni.
No reductions can be made.

NOVAMOBILI

DUO

BOISERIE SP. 2,7 CM
2,7 CM-THICK WALL PANNELLING

ALTEZZE (in cm)
HEIGHTS (cm)

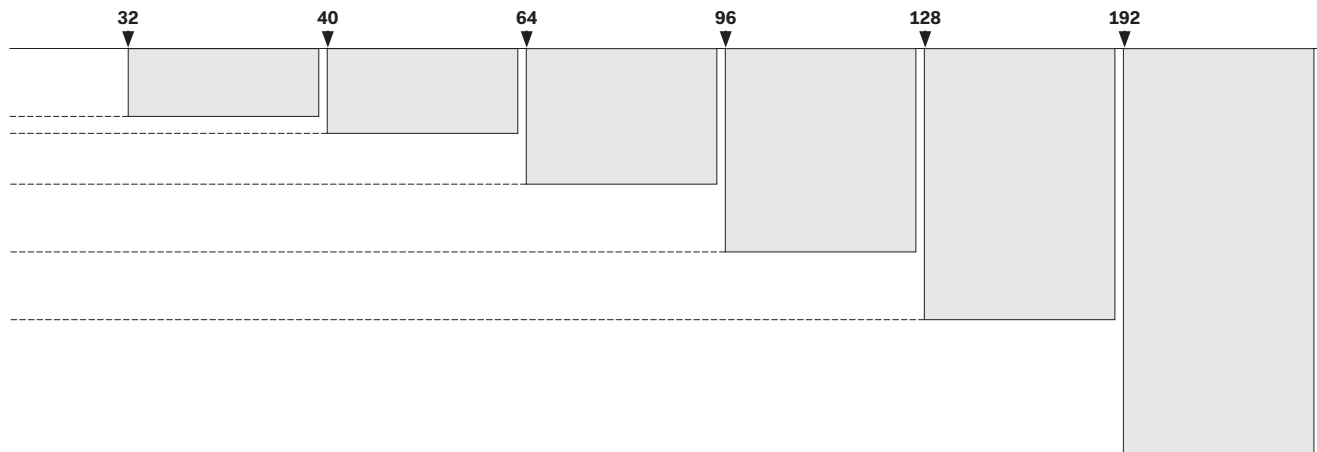

LARGHEZZE (in cm)	90	90	90	90	90	90	90
WIDTHS (cm)	120	120	120	120	120	120	120
	135	135	135	135	135	--	--
	150	150	150	150	150	--	--
	180	180	180	180	180	--	--

PROFONDITÀ (in cm)
DEPTHS (cm)

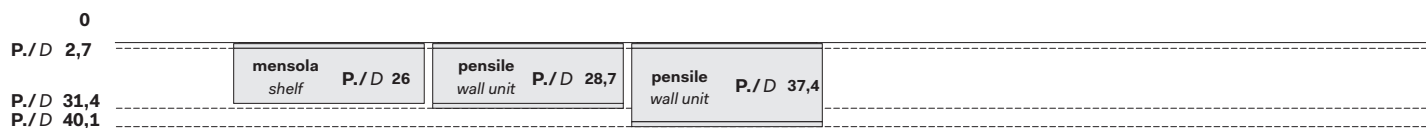

NOVAMOBILI

DUO

MENSOLE PER BOISERIE SP 2,7 CM

SHELVES FOR 2,7 CM-THICK WALL PANNELLING

COMPOSIZIONE CON BOISERIE CON MENSOLE DUO

WALL PANEL CONFIGURATION WITH DUO SHELVES

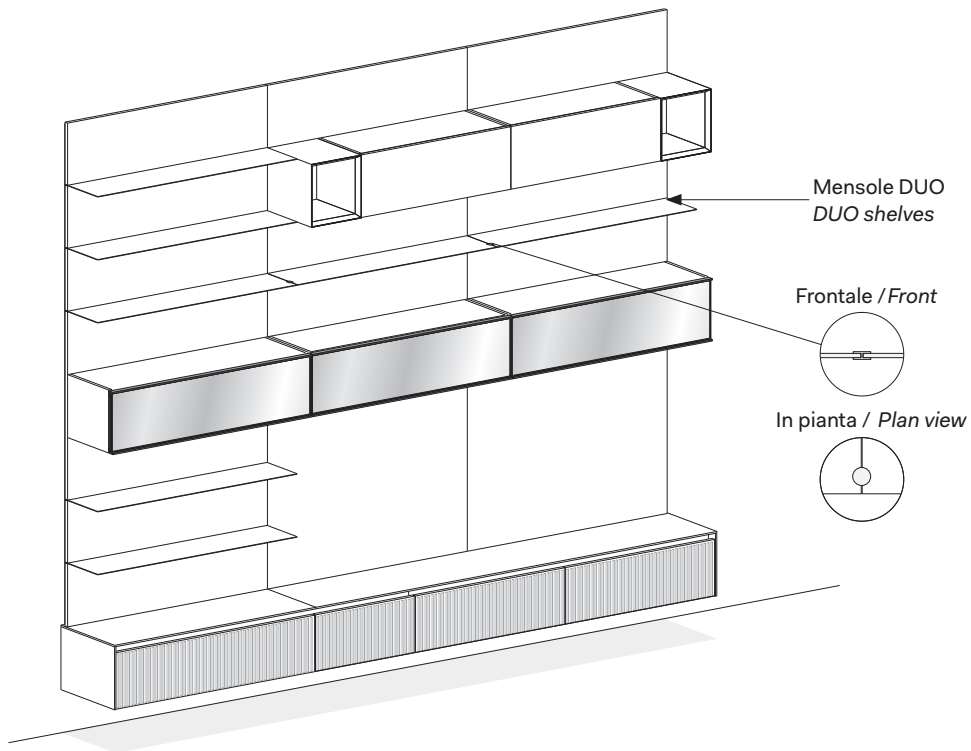

Particolare frontale e
in pianta dell'inserto
ad "H" in finitura
Nichel per mensole
DUO

Front and plan view of
H-shaped insert detail
in Nickel finish for
DUO shelves

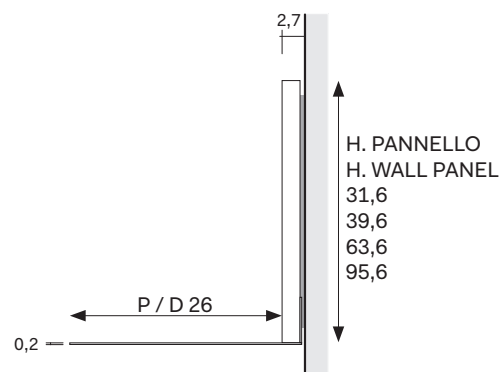

NOVAMOBILI

DUO

BOISERIE SP. 2,7 CM 2,7CM-THICK WALL PANNELLING

RETROILLUMINAZIONE PER BOISERIE SP 2,7 CM BACKLIGHTING FOR 2,7 CM-THICK WALL PANELS

Pannello sp. 1,8 cm al mq. con due fresate verticali e/o orizzontali per l'inserimento della luce LED.
Panel 1,8 cm thick per sq m with two vertical and/or horizontal grooves for inserting LED lighting.

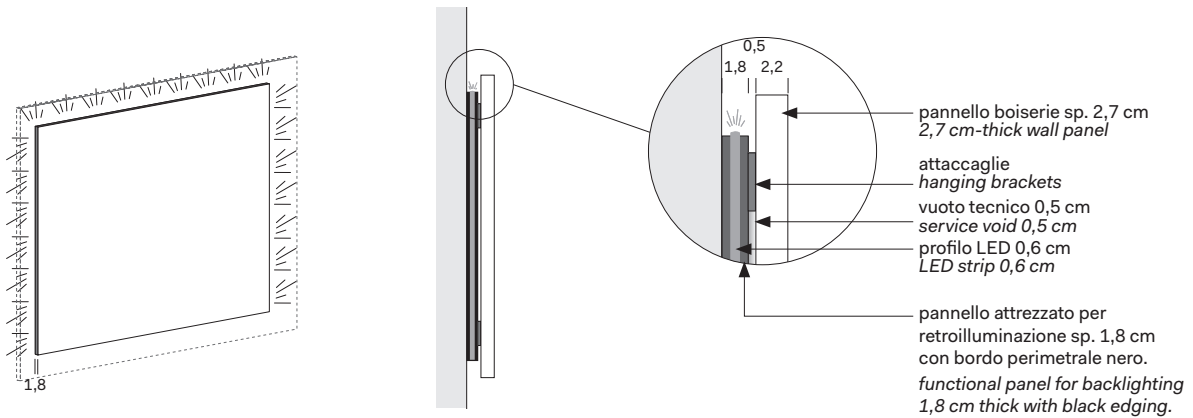

PANNELLO ORIZZONTALE HORIZONTAL PANEL

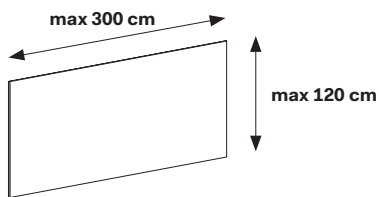

PANNELLO VERTICALE VERTICAL PANEL

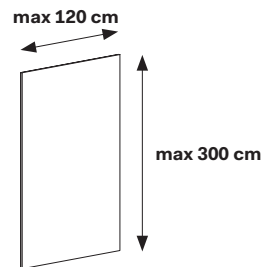

LUCE LED PER PANNELLI ATTREZZATI LED LIGHT FOR FUNCTIONAL PANELS

Luce LED 24V 3000K 24V 3000K LED light

Da completare con il trasformatore (vedi pag.8).
To be finished with transformer (see pag.8).

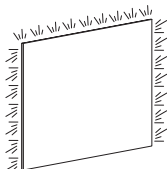

Dimensione minima L.20, max L.300 cm
Minimum length 20 cm max. 300 cm

NOVAMOBILI

DUO

BOISERIE SP. 2,7 CM 2,7CM-THICK WALL PANNELLING

TRASFORMATORE SMART SMART TRANSFORMER

Il trasformatore SMART può essere integrato con i moduli per il controllo remoto da applicazioni con tecnologia Bluetooth o Wi-Fi. Tramite le applicazioni dei moduli Bluetooth o Wi-Fi è possibile regolare l'intensità delle luci collegate al singolo trasformatore o a più trasformatori. Cavo 2 metri.

The SMART transformer can be integrated with modules for remote control via apps with Bluetooth or Wi-Fi technology. Via Bluetooth or Wi-Fi module apps, you can control the lighting level of lights connected to a single transformer or to a number of transformers. 2-metre cable.

Trasformatore SMART 15 W
15W SMART transformer

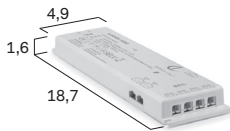

Sp. 1,6 L. 18,7 P. 4,9
Th 1,6 W 18,7 D 4,9
(max 4 luci LED)
(max. 4 LED lights)

Trasformatore SMART 30 W
30W SMART transformer

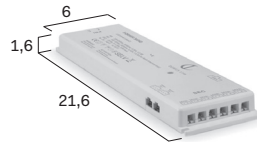

Sp. 1,6 L. 21,6 P. 6
Th 1,6 W 21,6 D 6
(max 6 luci LED)
(max. 6 LED lights)

Trasformatore SMART 60 W
60W SMART transformer

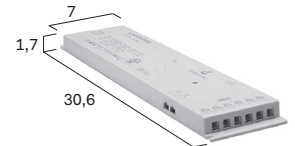

Sp. 1,7 L. 30,6 P. 7
Th 1,7 W 30,6 D 7
(max 6 luci LED)
(max. 6 LED lights)



I moduli opzionali Bluetooth e Wi-Fi vengono forniti con allegate istruzioni per il download delle relative applicazioni.

The optional Bluetooth and Wi-Fi modules come with instructions for downloading the relevant apps.



PASSACAVI PER BOISERIE SP 2,7 CM WIRING GROMMETS FOR 2,7 CM-THICK WALL PANEL

In metallo brunito.
Metal in bronze finish.

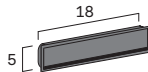

In plastica nero.
Black plastic.

